



Automation Systems AUSTRALIA



Simplified Installation Guide for 22/26AH Premier Solar System Assembly

This installation takes place after the gate automation has been installed and is ready for initial power up.

**ALWAYS reference your complete installation manual for travel time calibration
limit switches etc.**

Step 1: Solar Panel Assembly

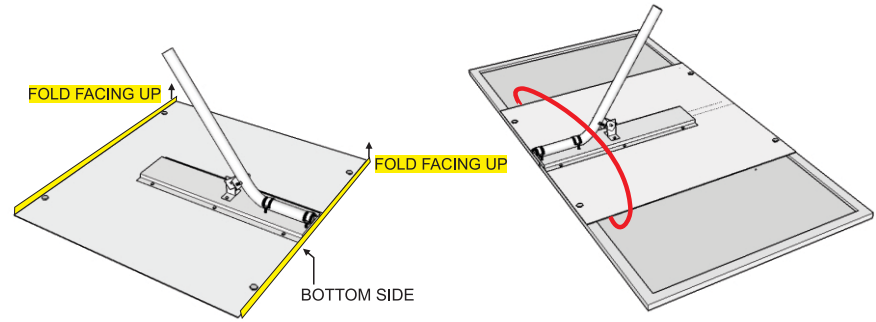
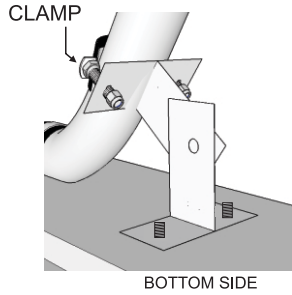
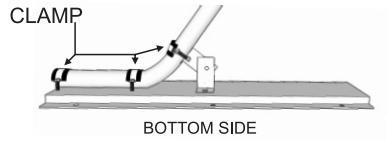

1. Install the curved end of the post to the narrow plate using the supplied pipe clamps, nuts, bolts and washers.

The bolt head should be on the bottom side with the threads facing upwards.

2. Install one T Section to the narrow plate, The bolt head should be on the bottom side with the threads facing upwards.

Install the other T Section and the other to the round post.

3. Install the larger plate to the narrow plate. The Fold of the plate should be facing upwards.

The bolt head should be on the bottom side with the threads facing upwards.

4. Install the solar panel to the large plate, the linking cable will remain on the outside, the large plate will slide within the loop.

In this step ONLY the bolt head should be on the top side with the threads facing towards the solar panel.

To install to the round post use another supplied pipe clamp

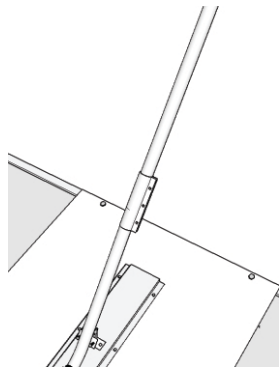

5. Install the extension band and extension post



6. Install to fence post or pier using the supplied pipe clamps.

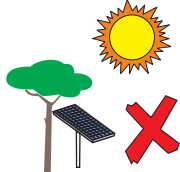

1. A solar panel CANNOT be installed under a tree, it requires sun to charge and maintain the batteries.

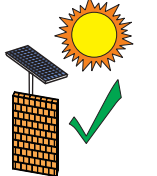

2. A solar system is often maintenance free BUT the batteries may require an external charge in the winter months due to lack of sun (rare).

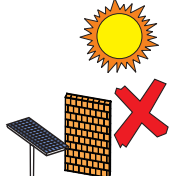

3. Constantly powered accessories such as wired keypads will increase the standby current draw, solar panel or battery upgrades may be required if sufficient collection is not achieved.

Step 2: Solar Panel Connection

Solar Panel connects into the Solar Panel connection port on the regulator.

Pass the cable through the bottom of the plastic box first as the regulator will be placed within the enclosure.

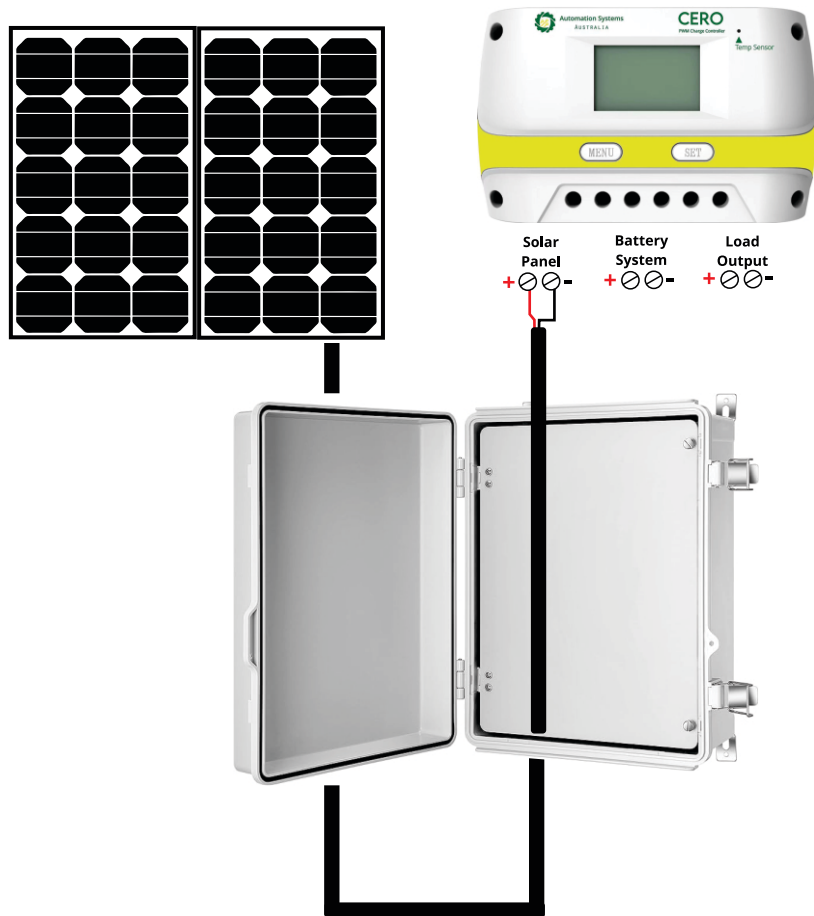

Step 3: Battery Installation

Batteries wired in series ONE BATTERY SITS ON TOP OF THE OTHER. The Cero Regulator will sit beside the bottom battery on its side at the end of installation.

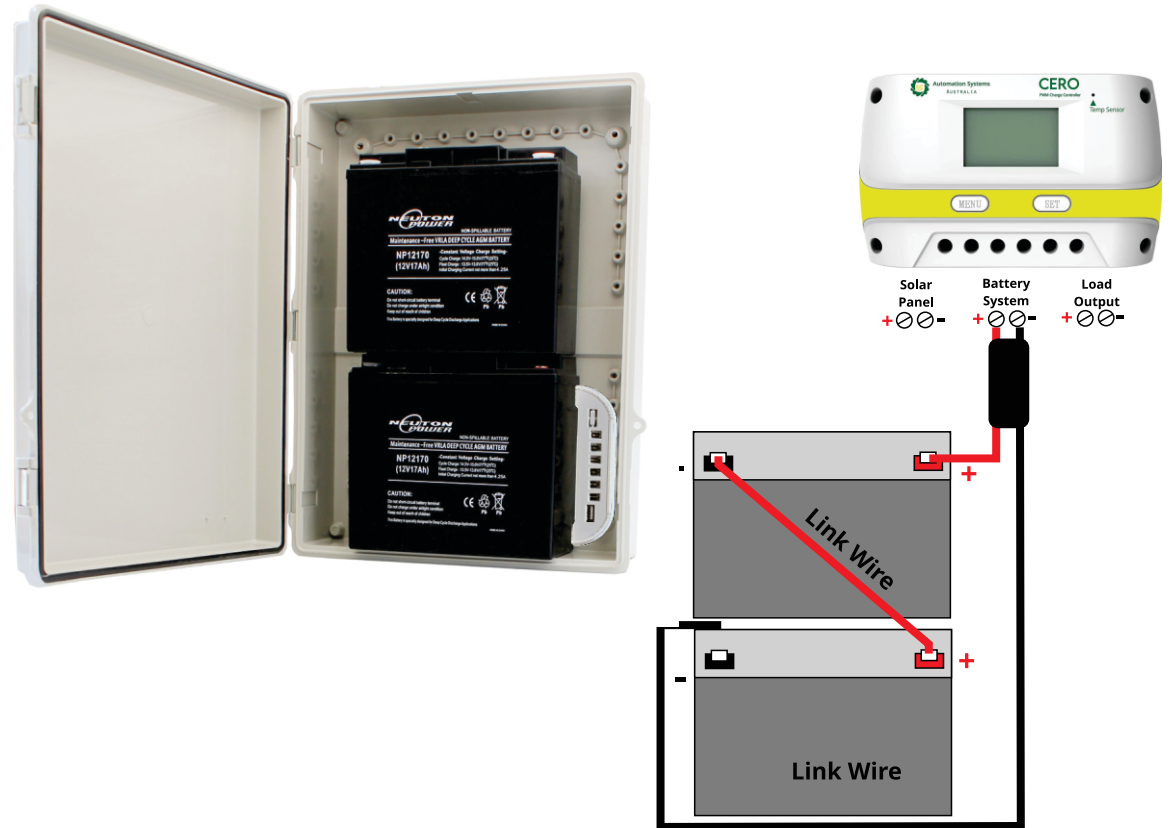

Shelf L
Positi

Step 4: Connection to the gate control board

Pass the cable through gate motor first then through then connect to the power input terminals 24V / 0V.

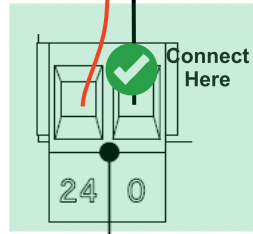
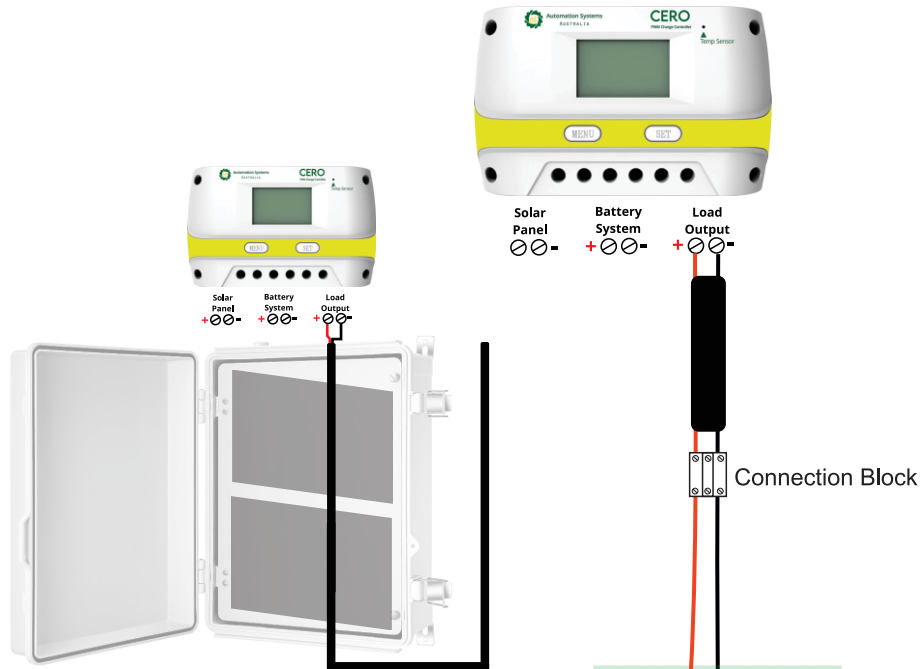

BXV/ZL65/ZLX24

Transformer Terminal 24V
Positive on (24)
Negative on (0V)

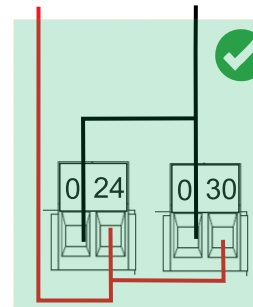
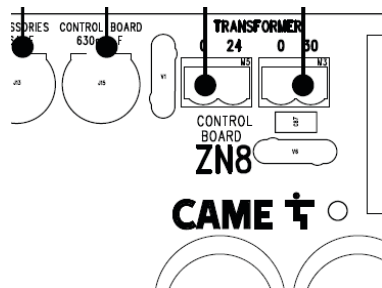

ZN8 BKV1500/BKV2000

Transformer Terminal 24 and 30V
Positive on (24 and 30)
Negative on LEFT SIDE (BOTH 0V)

BXV

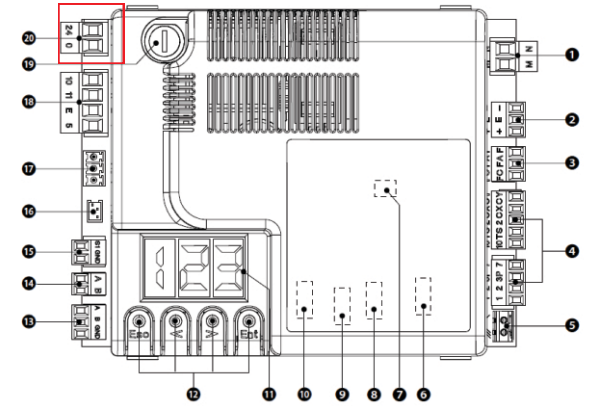

ZL65

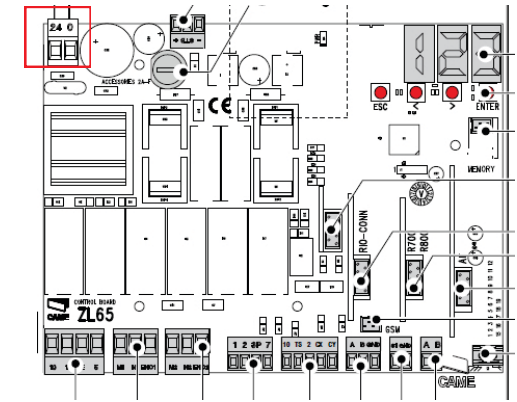

ZLX24

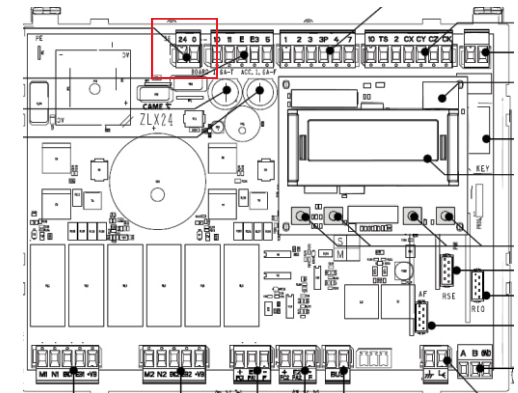

Step 5: Powering On and Validations



The Cero Solar Regulator by default is Auto-Detecting for the voltage setting and battery type, **no changes to its menu settings are required.**

The regulator will Auto-Enable the load output upon first powering On but can manually be toggled to ON/OFF using the SET button.

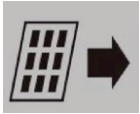

Solar Panel is outputting to the batteries



Battery Status

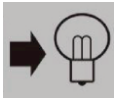

Load Output is ON and Sending Power to the Gate Controller

If OFF press the SET button



If Flashing check your wiring connections and press SET again.