

KPX Smart Intercom

Long Distance Intercom Setup Guide

This manual is **ADDITIONAL** to the KPX full system manual



AP Mode Setup

12V DC Power Adapter (Supplied)

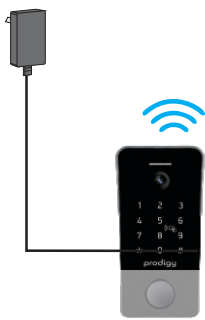

Up to 150 Metres providing clear line of sight and directional rules are adhered to.

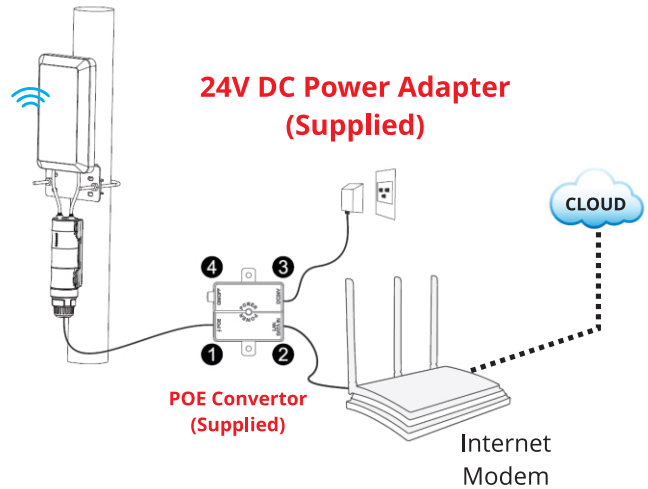

- 1). Connect the "⚡ POE" port of the PoE converter with an Ethernet cable with the WAN/LAN port of the device.
- 2). Connect the "LAN DATA IN" port of the PoE converter via another Ethernet cable to a "LAN" port on your router.
- 3). Plug the power plug into the "DC24V" port of the PoE converter, and then plug the power adapter into a power outlet.

ATTENTION:

1. Make sure you are using a certified CAT5e/CAT6 Ethernet cable with RJ45 connectors.
2. Make sure the Ethernet cable length is less than 60 meters (196 feet).
3. Please make sure that the diameter of the pillar of the fixed device is between 0.025m and 0.1m, otherwise the enclosed accessories cannot help to fix the device.
4. Supports PoE passive power supply over Ethernet cable.

Horizontal Angle

Vertical Angle

The system uses a DIRECTIONAL antenna, it is critical that the antenna is clear line of sight to the KPX intercom. Failure to do so will result in loss of operating range, failure to connect and also intermittent connection.

The range extender is weatherproof and MUST be installed on the outside the building or home.

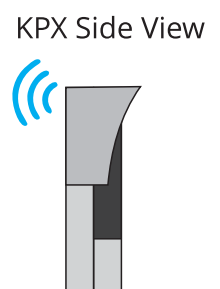
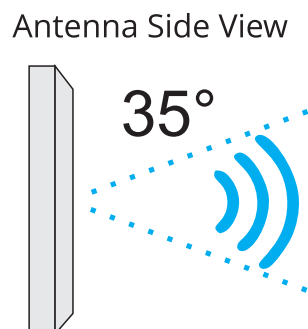
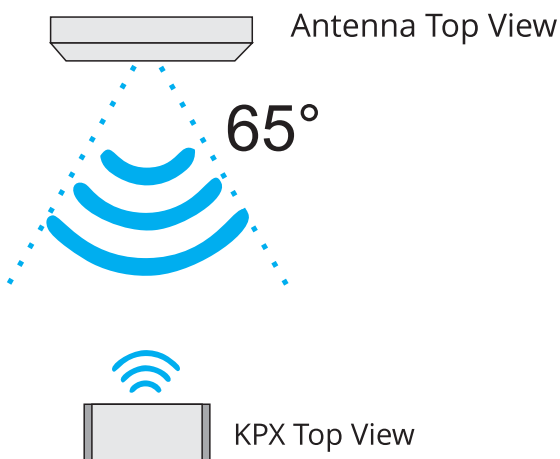

1.1 Via Wireless

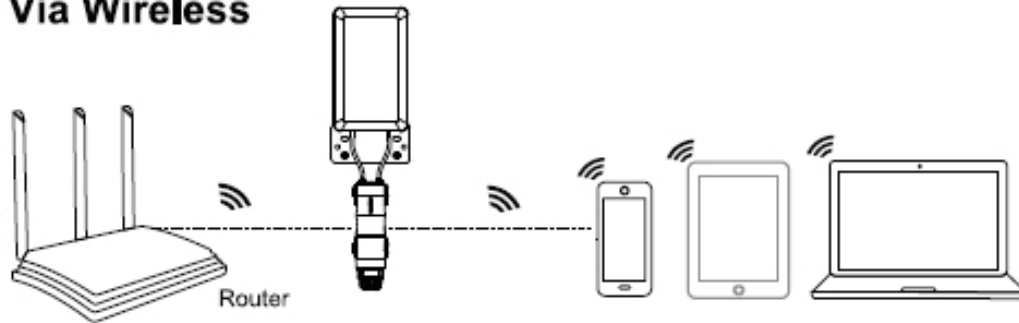

1. Disconnect the Ethernet cable from your computer (if you have one).
2. Turn on your WiFi, find the SSID of this product on your wireless devices (smartphone, tablet computer, laptop, etc.) and place a connection.



For Windows users



For Mac users

1.2 Via Cable

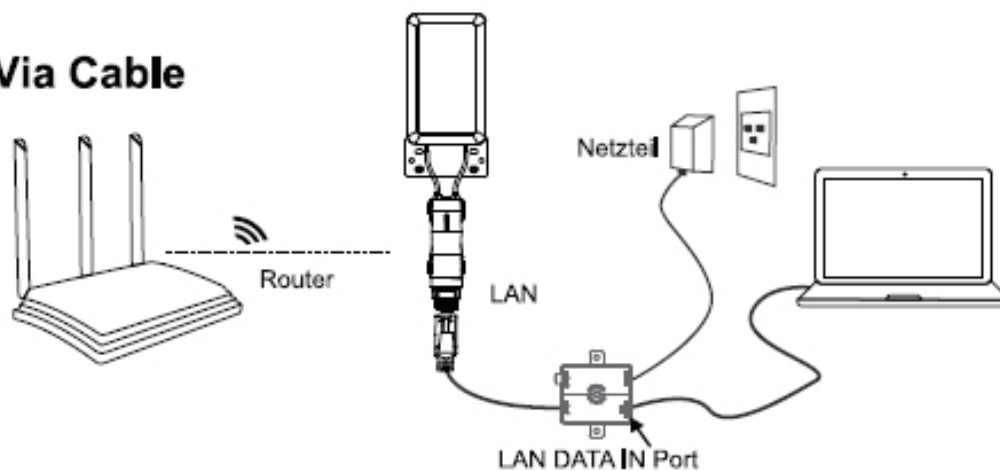

Connect the Ethernet cable to your PC/Laptop and the LAN DATA IN port of your PoE converter, then you can start the configuration of the device.

2. Launch a browser from your laptop/PC or smartphone and type wifi.wavlink.com or 192.168.10.1 in the address field. The default password is [admin](#).



3. Select your **Country/Region** and **Time Zone**. For your network security, we suggest that you set a new **Login Password**.

Country Region:

Time Zone:

Login Password:

Next

Tips:

For security reasons, the password must be greater than or equal to six

4. Wizard

4.1 LAN Bridge (AP Mode)

① Click **Wizard > AP.**



② Choose a Security Type. Enter your Wi-Fi password (extended network password).

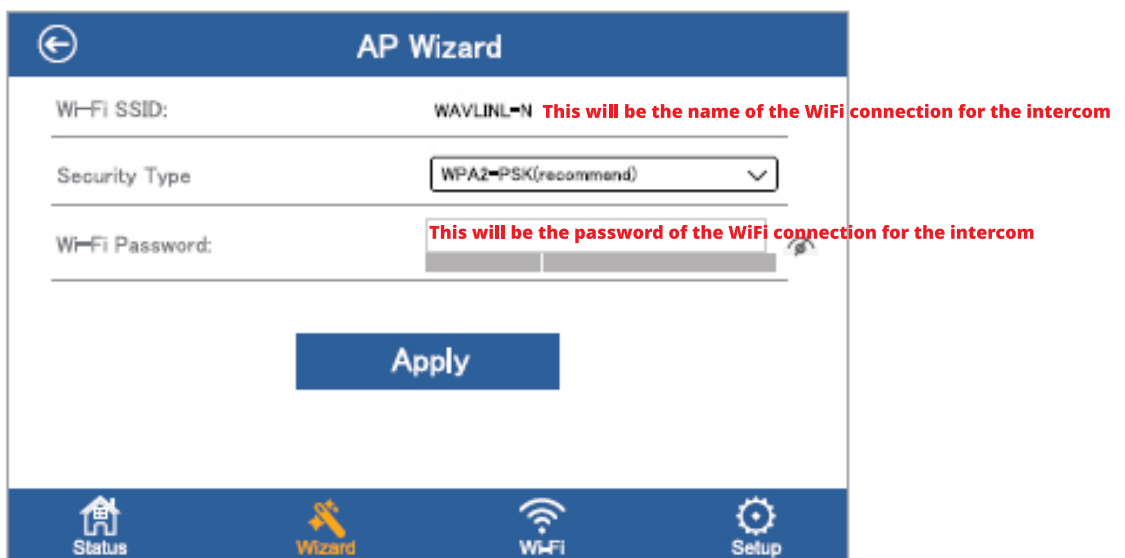

Adding the FIRST user (System Administrator)

1. Download the app by scanning the QR code OR download directly from the APP Store.



Tuya Smart app



Smart Life app

2. Register an account or sign in if you already have an account. ENSURE you use the correct country upon registration.

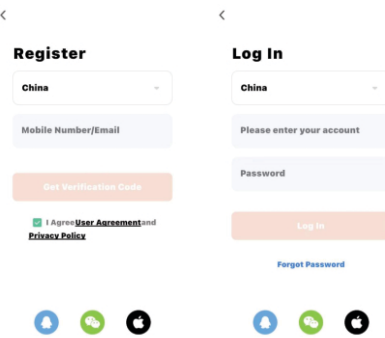

Creating a Shareable Home

This is a required step if you wish to share access with other users. If you plan to be the only user please disregard and add the device (next section).

1. From the settings select MY HOME on the first users APP, add the relevant "rooms" or create a new room.

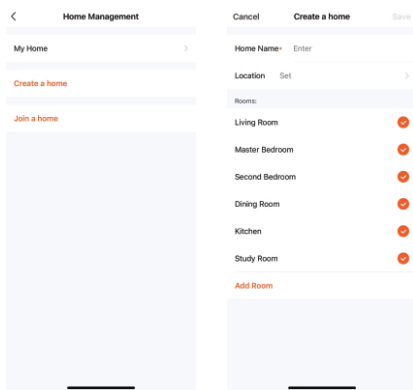

2. Add a user to the HOME and assign their privileges via Family Role, they could be common users (normal user) or an Administrator. note: Any users being added must have already registered and signed into their account

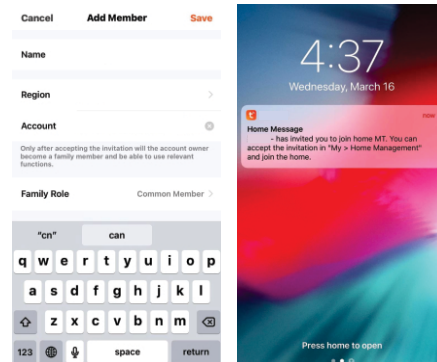

3. The new user(s) now have access to the HOME devices after they accept, begin to add the device in the next section.

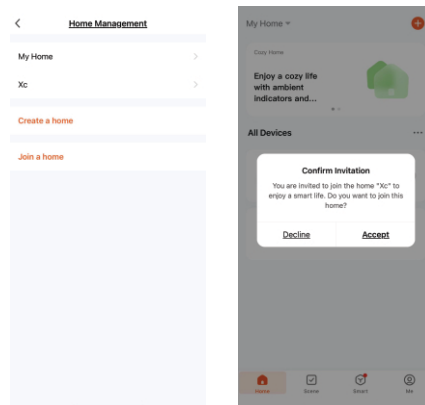

1. Before beginning ensure you are on the correct HOME. Select Camera & Lock then select Smart Doorbell

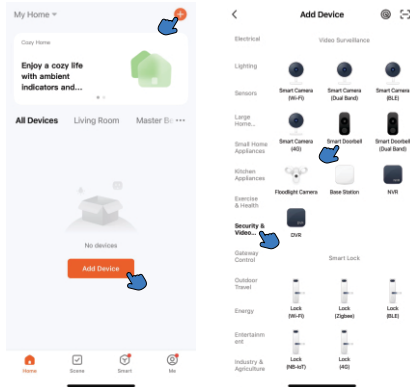

2. Select QR Code for Camera

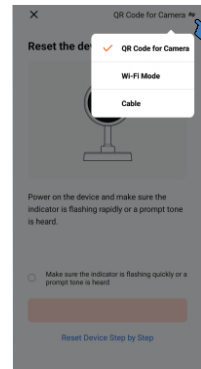

QR Code (Wi-Fi Connection)

ENSURE you are already connected to the 2.4GHZ Wi-Fi network (this is the New WiFi Network setup in the previous steps)

Hold the QR Code 10-15cm away from the camera til a quick beep is heard then select I HEARD THE PROMPT.

If you are unable to have the device read the QR CODE it may be to glare or reflections.

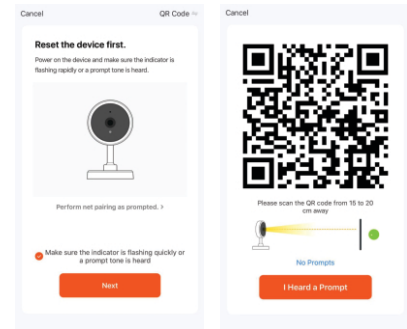

The device typically takes 1-2 minutes to complete the search and configuration. Once complete you will be taken to the real time video stream.

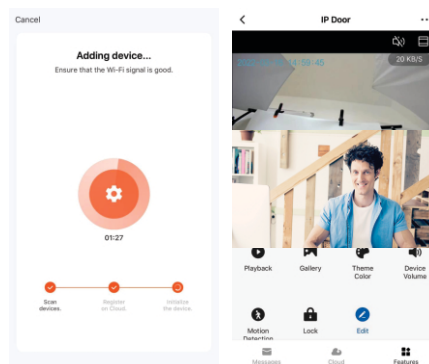

Warranty Terms and Conditions

The product is warranted for a period of twelve months (one year) from the date of purchase, unless expressly specified as extended warranty (extension to the warranty period). The product is to be installed for its intended purpose and for normal use as outlined within the installation manual, the product warranty is exclusively for defects in manufacturing and manufacturing workmanship. It does not cover out of guidelines use, natural or other disasters, abnormal weather conditions, damage incurred in shipping or handling, damage caused by disaster such as fire, flood, wind, earthquake, lightning, excessive voltage, mechanical shock, water damage, damage caused by unauthorized attachment, alterations, modifications, or foreign objects, damage caused by peripherals (unless such peripherals were supplied by Prodigy), defects caused by failure to provide a suitable installation environment for the products, damage caused by usage of the products for purpose other than those for which it was designed, damage from improper maintenance, damage arising out of any other abuse, mishandling, and improper application of the products.

At its discretion Prodigy will require the item determined by the support staff to be returned to base in its original unmodified condition for a warranty inspection if within the warranty period. A return authorization "RA" number will be provided to be enclosed with the product in question. The warranty will not cover freight fees to base, customs fees or any labour costs at the installation site but will cover repair or replacement of the product as seen fit. Prodigy will cover the freight of the returned item to the original address if deemed as a warranty repair or replacement item. Any warranty repairs or replacements continue to carry through the remaining warranty period and do not extend or restart the period.

Under no circumstances shall Prodigy be liable for any special, incidental, or consequential damages based upon breach of warranty, breach of contract, negligence, strict liability, or any other legal theory. Such damages include, loss of profits, loss of the product or any associated equipment, cost of capital, cost of substitute or replacement equipment, facilities or services, down time, purchaser's time, the claims of third parties, including customers, and injury to property.

This warranty contains the entire warranty and shall be in lieu of any and all other warranties, whether expressed or implied (including all implied warranties of merchantability or fitness for a particular purpose). And of all other obligations or purporting to act on its behalf to modify or to change this warranty, nor to assume for it any other warranty or liability concerning this product.

Prodigy will at its option repair or replace out-of-warranty products at a determined cost which are returned to its base according to the following conditions. Anyone returning goods to Prodigy must first obtain an authorization number. Prodigy will not accept any shipment whatsoever for which prior authorization has not been obtained. Products which Prodigy determines to be repairable will be repaired and returned. A set fee which Prodigy has been predetermined and which may be revised from time to time will be charged for each unit repaired. Products which Prodigy determines not repairable will be replaced by the nearest equivalent product available at that time. The current market price for the replacement product will be charged for each replacement unit.