

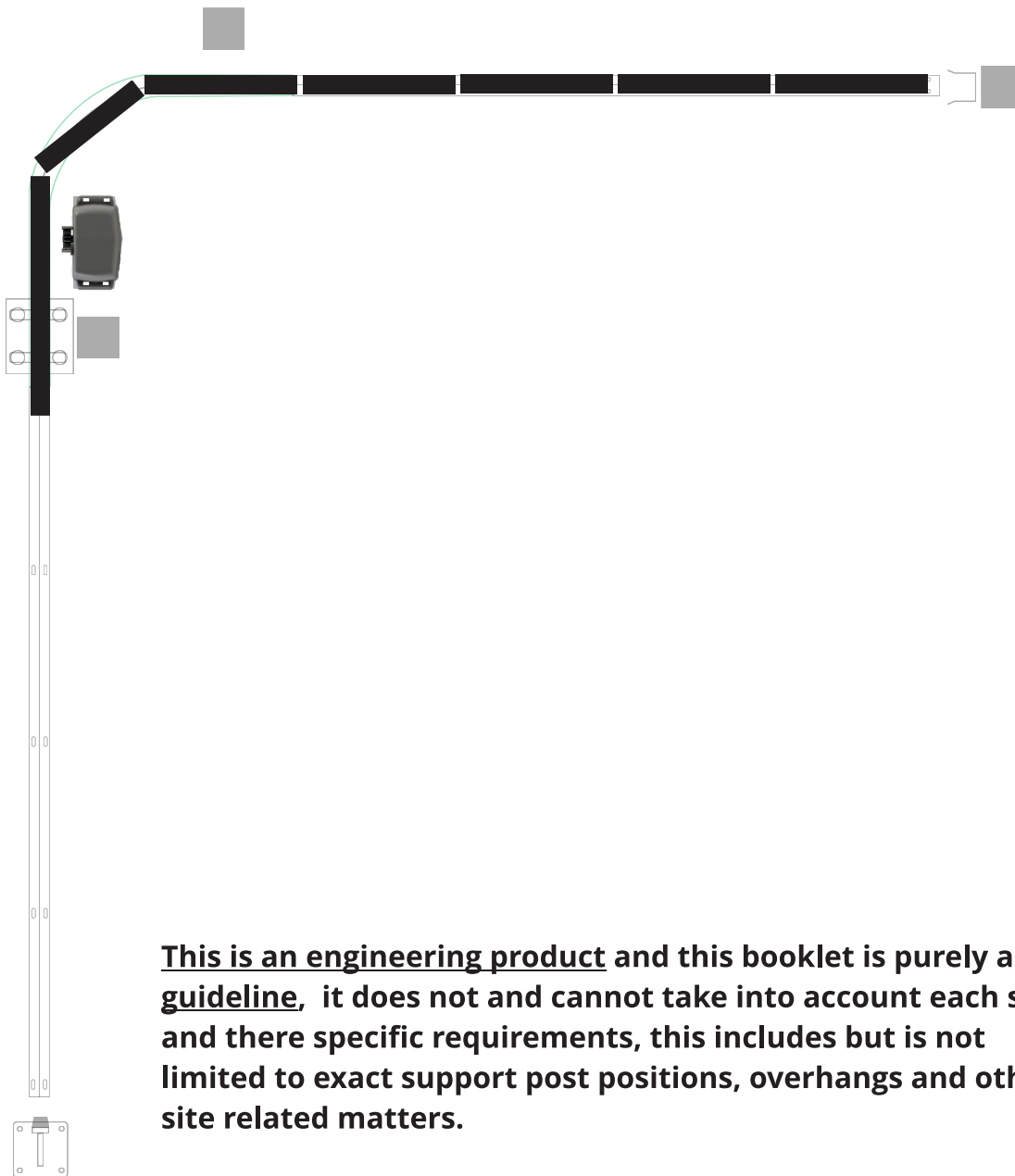

# Automation Systems AUSTRALIA

## Radius Sliding Gate Installation Guideline (V3SL Wheel Type)



**This is an engineering product and this booklet is purely a guideline, it does not and cannot take into account each site and there specific requirements, this includes but is not limited to exact support post positions, overhangs and other site related matters.**

## Precautions:

1. The operating plane must be level both across the opening and also the return area, the radius gate hinge systems has minimal tolerance for up/down panel manoeuver.
2. The provided divisions of 500mm/1000mm/1500mm are based on GR5K sliding gear rack with allowance for hinging gap and allowing the joint to stay flush with the gate panel although if required the panels could be slightly shorter/longer with overhang, the maximum supported panel size is 1800mm

## Gate Structure Guideline

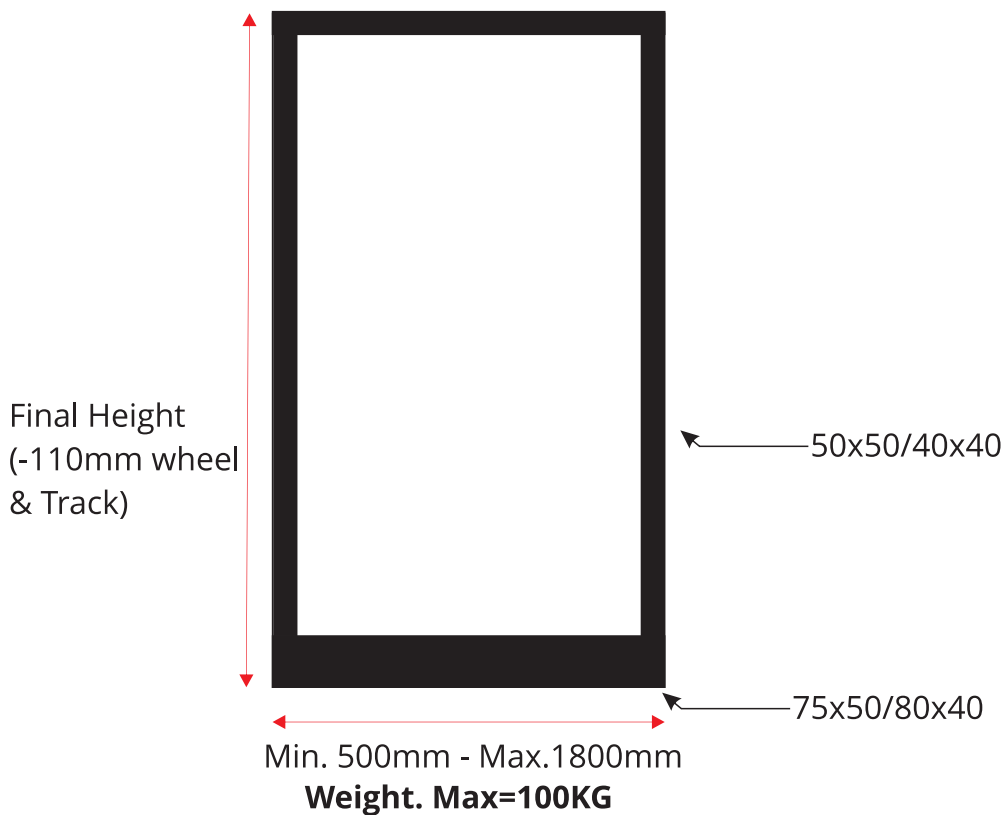

# Kit Hardware



RADIUS-V3SL-WHL

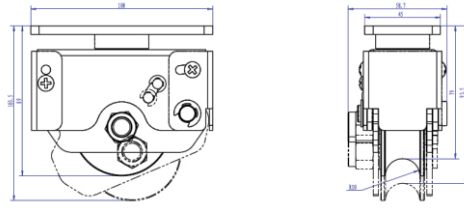

RADIUS-HINGE

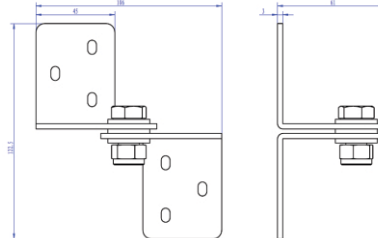

SGT-1M-TURN90

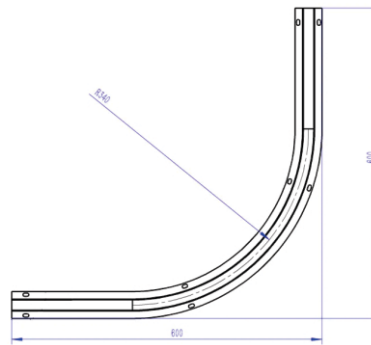

NR-WH-3040-BR-60105

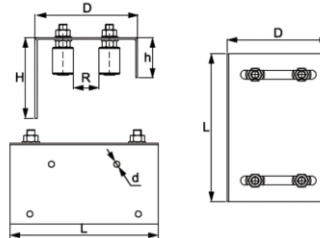

R(mm)	L(mm)	D(mm)	d(mm)	H(mm)	h(mm)
0/110	300	210	13	180	82



SGT-1M/2M/3M

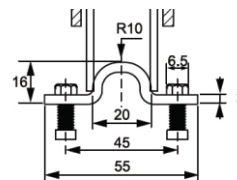

SGS-145

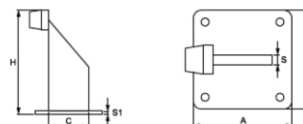

AxB (mm)	C(mm)	S(mm)	S1(mm)	H(mm)
100x100	60	10	6	145

# Installation

## Step 1 (Perpendicular Method)

Calculating the gate panel sizes (parallel method on next page).

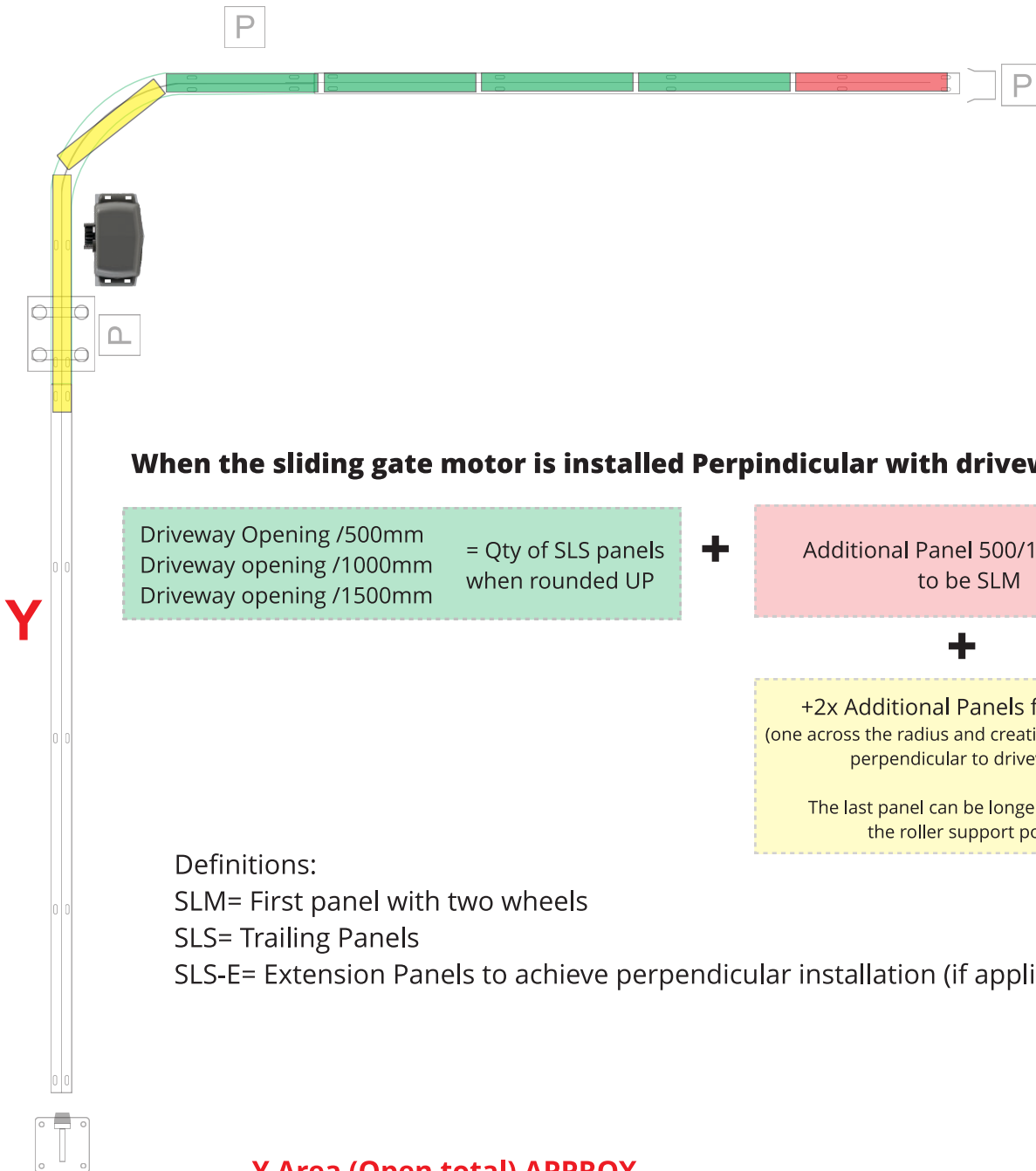

### Y Area (Open total) APPROX.

- Qty of SL panels \* 15mm= Gaps Total mm
- + measurement of SL panels= SL panels total mm
- + measurement of the SLM panel in mm
- + 1x SLS-E (Longest)

## Step 1 (Parallel Method)

Calculating the gate panel sizes (perpendicular method on previous page).

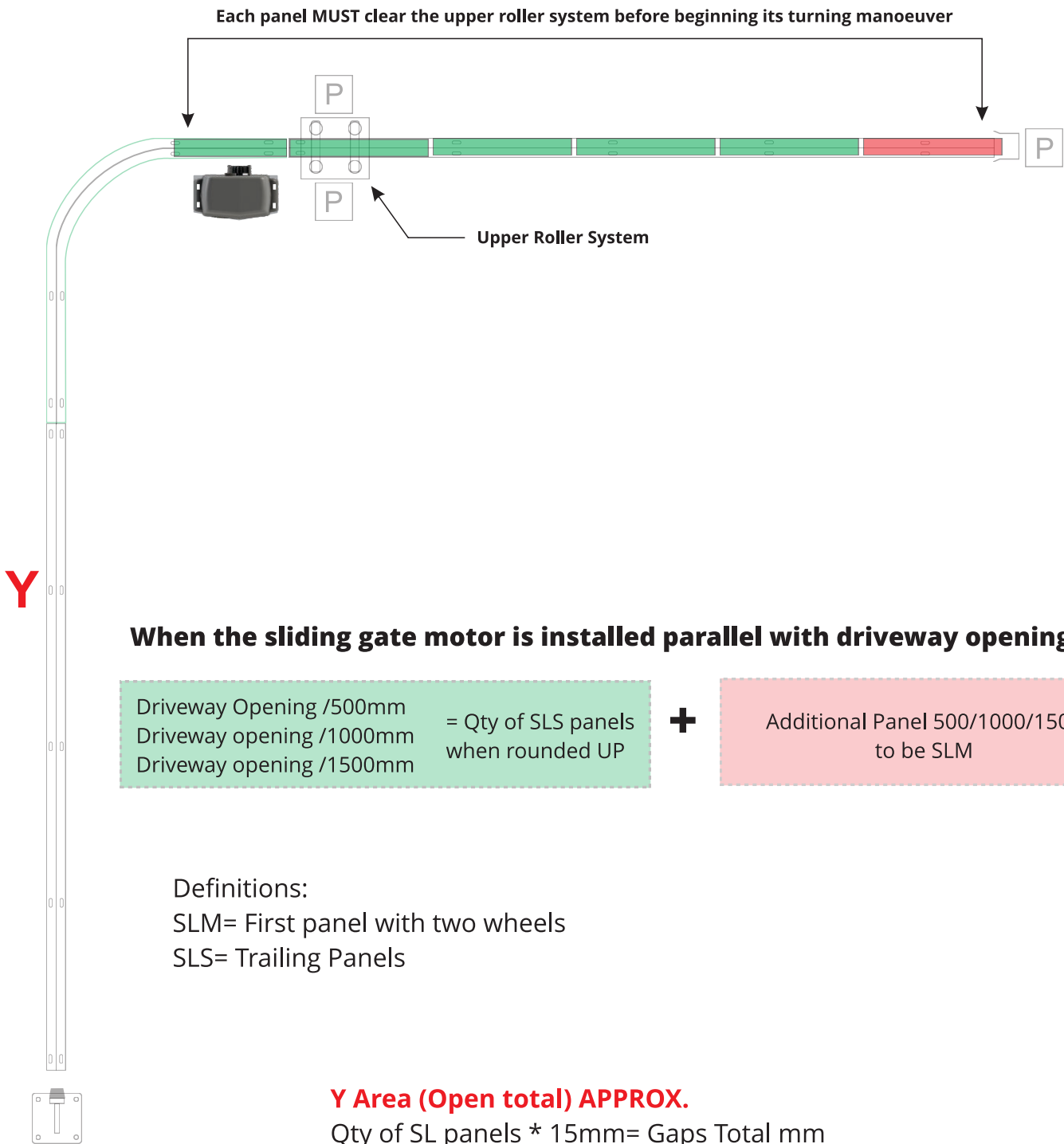

### When the sliding gate motor is installed parallel with driveway opening

Driveway Opening /500mm  
Driveway opening /1000mm  
Driveway opening /1500mm

= Qty of SLS panels  
when rounded UP

+

Additional Panel 500/1000/1500  
to be SLM

Definitions:

SLM= First panel with two wheels

SLS= Trailing Panels

### Y Area (Open total) APPROX.

Qty of SL panels \* 15mm= Gaps Total mm

+ measurement of SL panels= SL panels total mm

+ measurement of the SLM panel in mm

## Step 2

Install TWO wheels to SLM panel, this is the first panel against the closed position post.

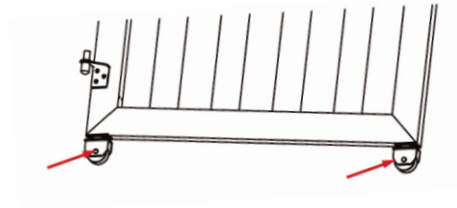

## Step 3

Install ONE wheel to the each SLS panel at the opening direction end, if an SLE panel exists use the same technique.

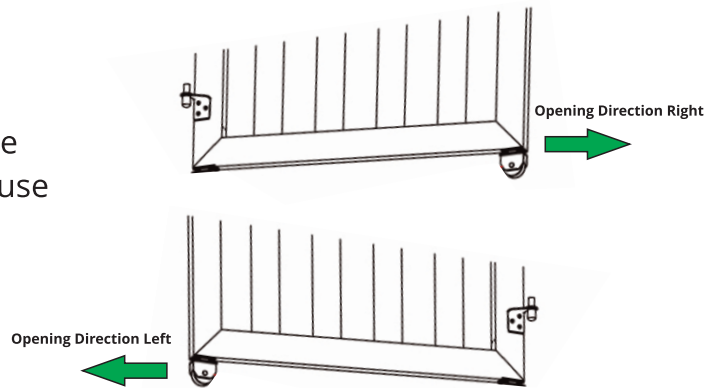

## Step 4

Install all gate panels with a 15mm clear hinge gap, ensure top hinge does not conflict with upper roller guide and ensure the bottom hinge does not conflict with the gear rack. A simple rule is to install the hinges 200mm from top and bottom of the panel.

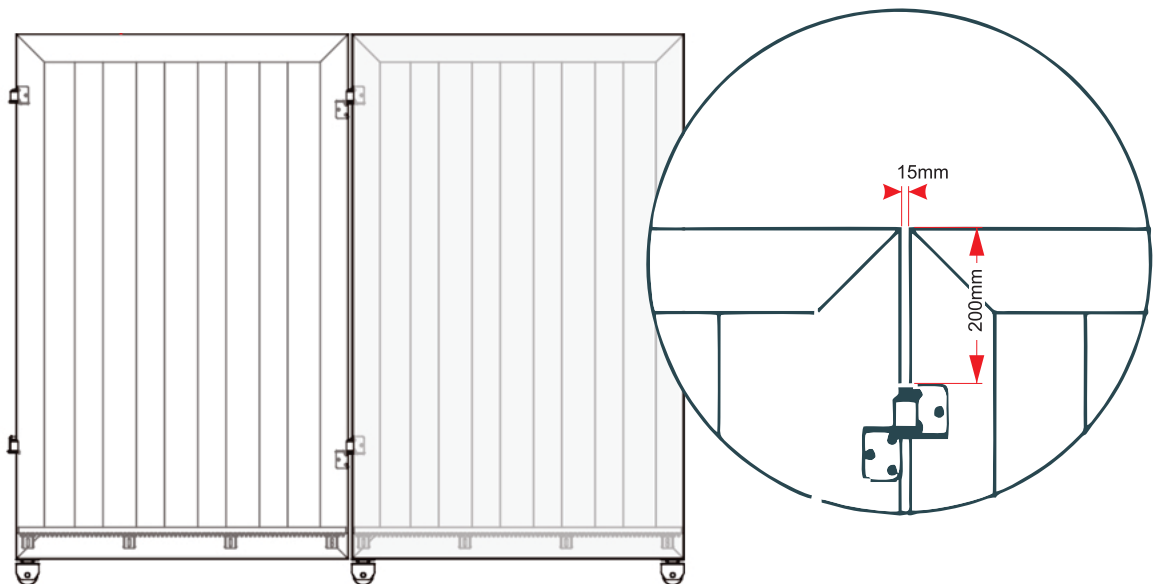

**Step 5**

Install the open position TALL end stop

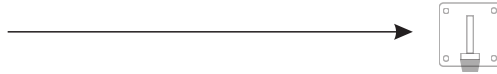

**Step 6**

Install all panels in place and set the four point roller system

**Step 7**

6. Install the closed position gate catcher

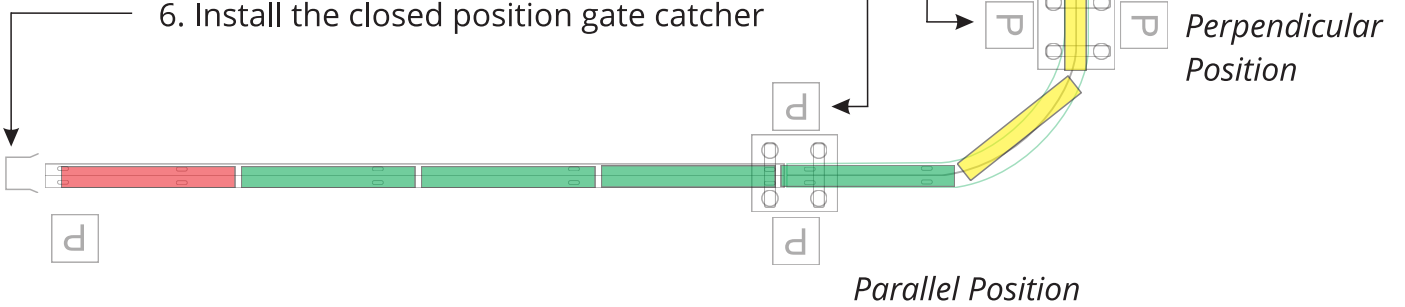

## Step 8

Install the Titan 2410 Sliding gate motor following the normal installation steps with a few minor exceptions:

1. A Titan riser kit is required to align with gates bottom rail.
2. A slice through the gear rack at the exact centre of hinge gap, the cut is made after installing the gear rack.
3. FS Setting should be decreased to "04" then calibration is required.

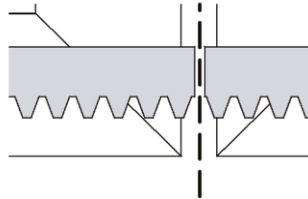

### Warranty Terms and Conditions

The product is warranted for a period of twelve months (one year) from the date of purchase, unless expressly specified as extended warranty (extension to the warranty period). The product is to be installed for its intended purpose and for normal use as outlined within the installation manual, the product warranty is exclusively for defects in manufacturing and manufacturing workmanship. It does not cover out of guidelines use, natural or other disasters, abnormal weather conditions, damage incurred in shipping or handling, damage caused by disaster such as fire, flood, wind, earthquake, lightning, excessive voltage, mechanical shock, water damage, damage caused by unauthorized attachment, alterations, modifications, or foreign objects, damage caused by peripherals (unless such peripherals were supplied by Automation Systems Australia), defects caused by failure to provide a suitable installation environment for the products, damage caused by usage of the products for purpose other than those for which it was designed, damage from improper maintenance, damage arising out of any other abuse, mishandling, and improper application of the products.

At its discretion Automation Systems Australia will require the item determined by the support staff to be returned to base in its original unmodified condition for a warranty inspection if within the warranty period. A return authorization "RA" number will be provided to be enclosed with the product in question. The warranty will not cover freight fees to base, customs fees or any labour costs at the installation site but will cover repair or replacement of the product as seen fit. Automation Systems Australia will cover the freight of the returned item to the original address if deemed as a warranty repair or replacement item. Any warranty repairs or replacements continue to carry through the remaining warranty period and do not extend or restart the period.

Under no circumstances shall Automation Systems Australia be liable for any special, incidental, or consequential damages based upon breach of warranty, breach of contract, negligence, strict liability, or any other legal theory. Such damages include, loss of profits, loss of the product or any associated equipment, cost of capital, cost of substitute or replacement equipment, facilities or services, down time, purchaser's time, the claims of third parties, including customers, and injury to property.

This warranty contains the entire warranty and shall be in lieu of any and all other warranties, whether expressed or implied (including all implied warranties of merchantability or fitness for a particular purpose). And of all other obligations or purporting to act on its behalf to modify or to change this warranty, nor to assume for it any other warranty or liability concerning this product.

Automation Systems Australia will at its option repair or replace out-of-warranty products at a determined cost which are returned to its base according to the following conditions. Anyone returning goods to Automation Systems Australia must first obtain an authorization number. Automation Systems Australia will not accept any shipment whatsoever for which prior authorization has not been obtained. Products which Automation Systems Australia determines to be repairable will be repaired and returned. A set fee which Automation Systems Australia has been predetermined and which may be revised from time to time will be charged for each unit repaired. Products which Automation Systems Australia determines not repairable will be replaced by the nearest equivalent product available at that time. The current market price for the replacement product will be charged for each replacement unit.