

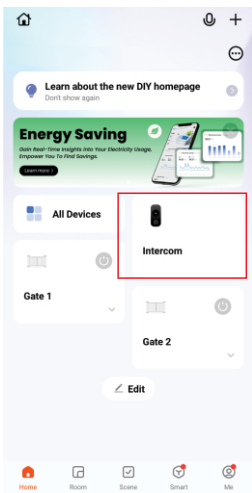

- Page 1 GateKeeper General Controls
- Page 2 GateKeeper Electric Systems Diagrams
- Page 3 Solar Panel Assembly
- Page 4 GateKeeper Dedicated Solar System Diagrams (Swing Gate - Premier Sw24)
- Page 5 GateKeeper Dedicated Solar System Diagrams (Sliding Gate - Titan 2410)

### SOLAR SYSTEM - Enable Power Saving Mode

This setting takes place AFTER a successful registration and adding the device and power on of the device.



Select INTERCOM

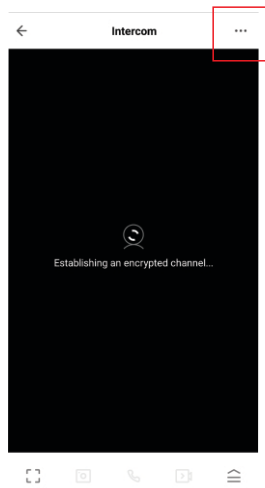

Select ... in the top right corner

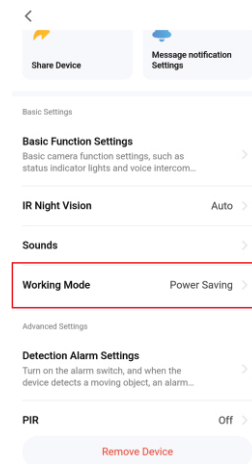

Change the Working Mode to Power Saving Mode and press SAVE

### Gate Operation

Gate Operation always takes place from the home screen in the Tuya Smart APP.

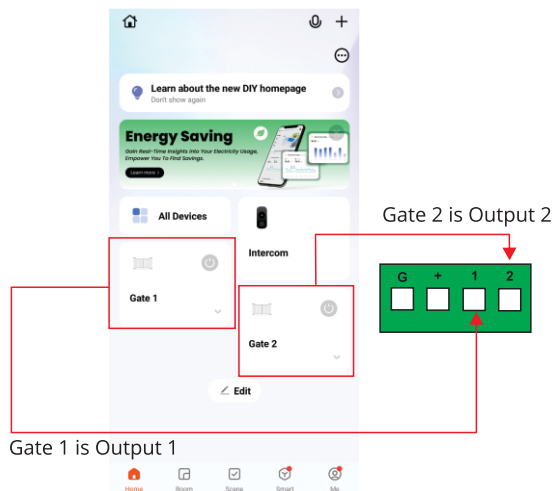

(Orion/Orion-LS, Raptor, Apache, Viper) Premier SW24 Swing Gate Controller

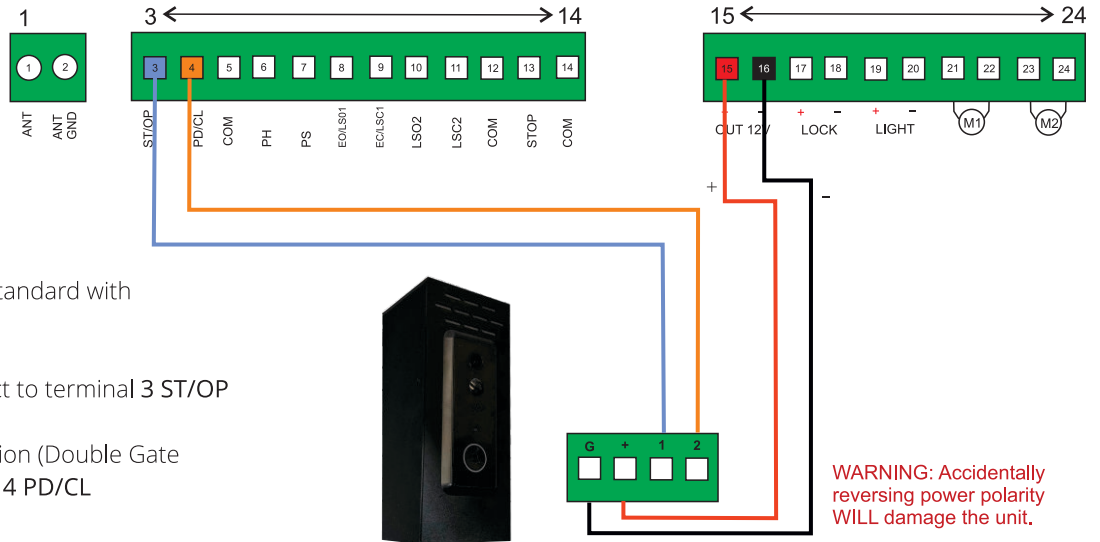

Using Logic Mode "Standard" or "Standard with Automatic Closing Timer"

For Double Gate operation connect to terminal 3 ST/OP

For Single/Pedestrian Gate Operation (Double Gate Systems Only) connect to terminal 4 PD/CL

**WARNING: Accidentally reversing power polarity WILL damage the unit.**

(TITAN 2410) Premier SL24 Sliding Gate Controller

Using Logic Mode "Standard" or "Standard with Automatic Closing Timer"

For Full Gate operation connect to terminal 3 ST/OP

For Pedestrian Gate Operation connect to terminal 4 PD/CL

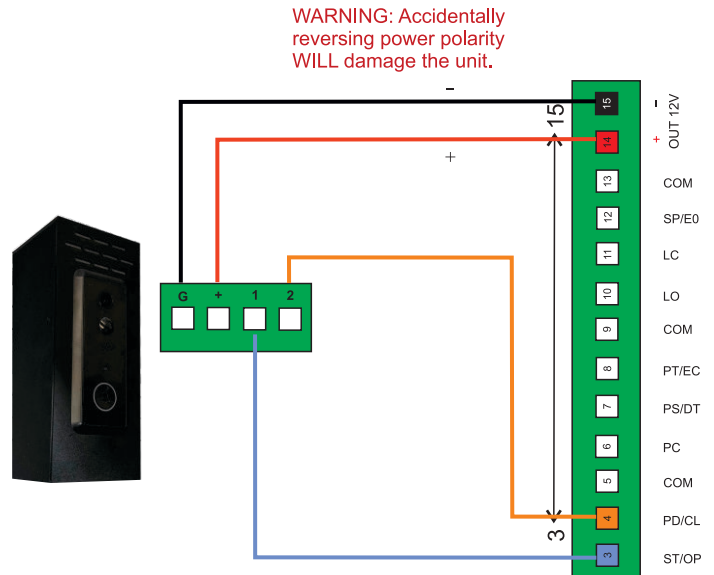

**WARNING: Accidentally reversing power polarity WILL damage the unit.**

(TITAN 1000) Premier SL240AC Sliding Gate Controller

For Full Gate operation OPEN and CLOSE connect to terminal START 19

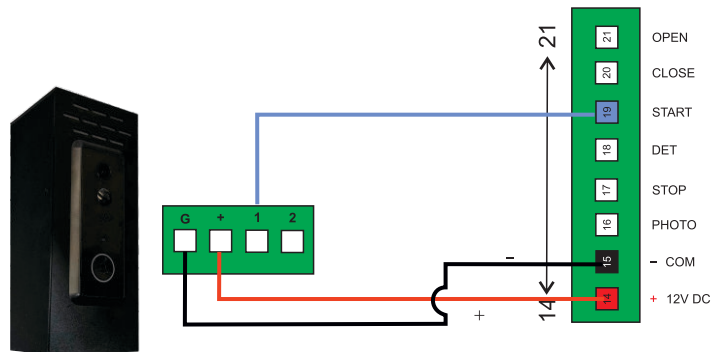

**WARNING: Accidentally reversing power polarity WILL damage the unit.**

# Step 1: Solar Panel Assembly

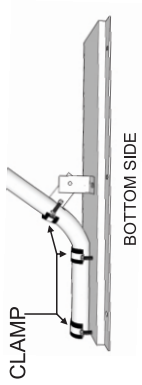

1. Install the curved end of the post to the narrow plate using the supplied pipe clamps, nuts, bolts and washers.

The bolt head should be on the bottom side with the threads facing upwards.

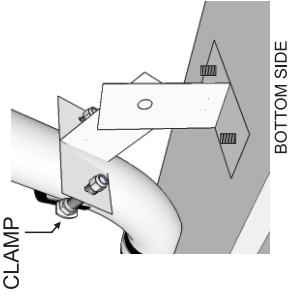

2. Install one T Section to the narrow plate. The bolt head should be on the bottom side with the threads facing upwards.

Install the other T Section and the other to the round post.

To install to the round post use another supplied pipe clamp

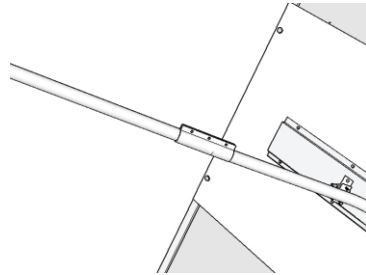

5. Install the extension band and extension post

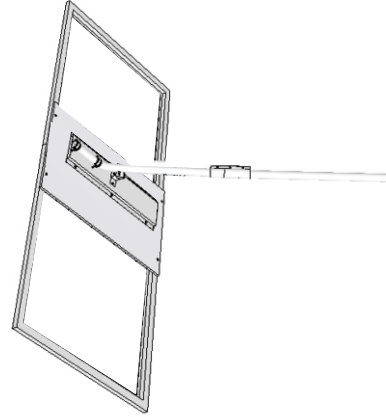

6. Install to fence post or pier using the supplied pipe clamps.

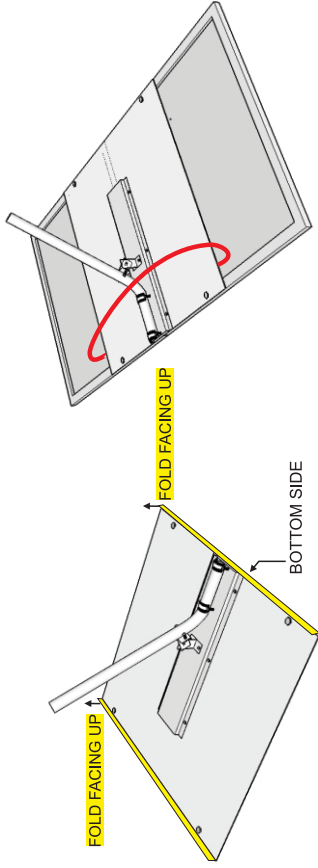

3. Install the larger plate to the narrow plate. The Fold of the plate should be facing upwards.

The bolt head should be on the bottom side with the threads facing upwards.

4. Install the solar panel to the large plate, the linking cable will remain on the outside, the large plate will slide within the loop.

In this step ONLY the bolt head should be on the top side with the threads facing towards the solar panel.

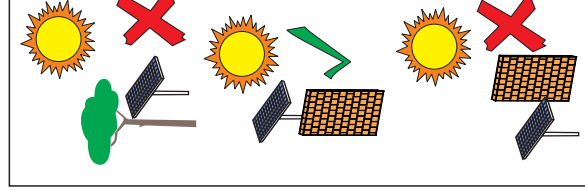

1. A solar panel **CANNOT** be installed under a tree, it requires sun to charge and maintain the batteries.
2. A solar system is often maintenance free **BUT** the batteries may require an external charge in the winter months due to lack of sun (rare).
3. Constantly powered accessories such as wired keypad **will** increase the standby current draw, solar panel or battery upgrades may be required if sufficient collection is not achieved.

(Orion/Orion-LS, Raptor, Apache, Viper) Premier SW24 Swing Gate Controller

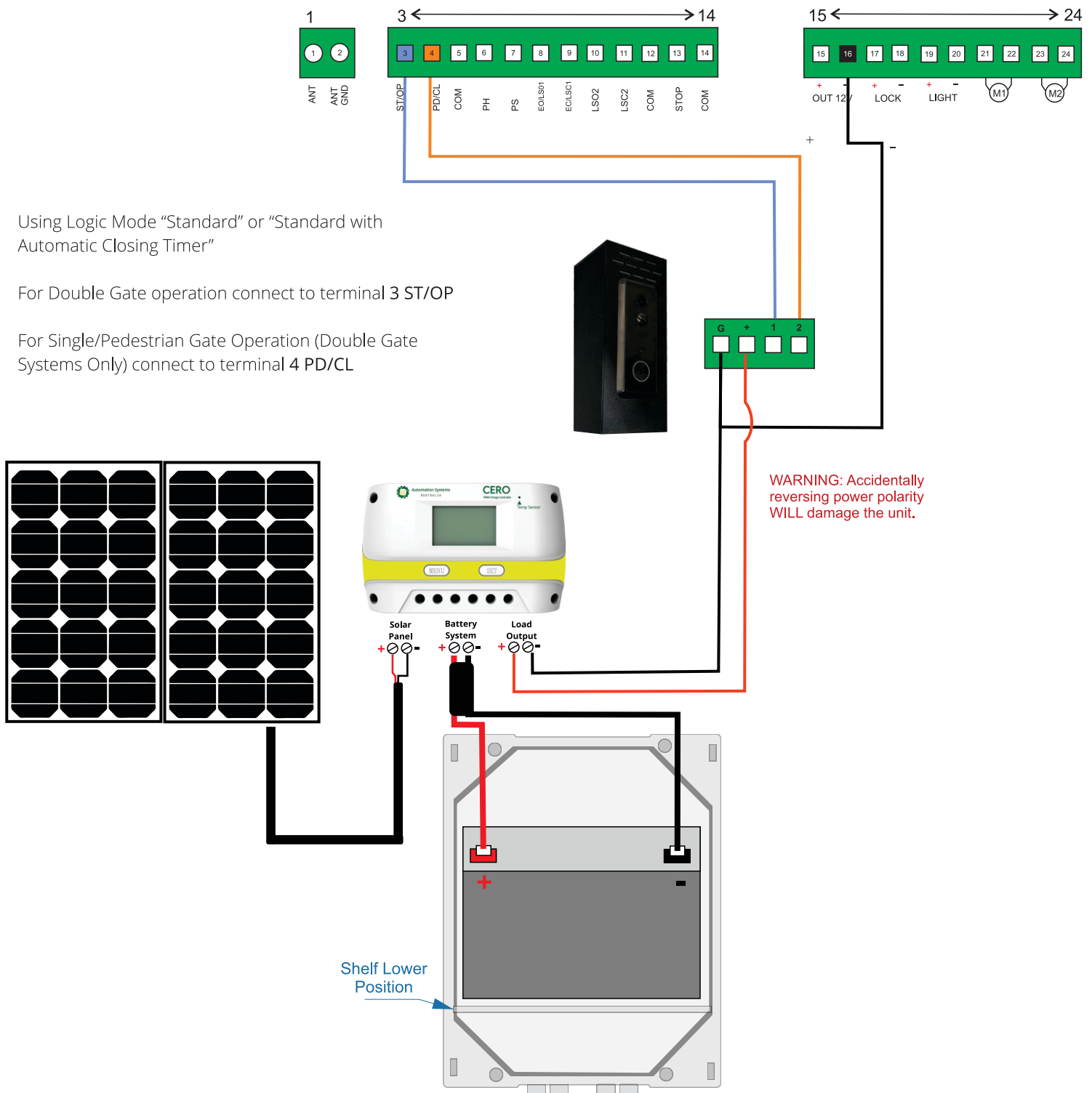

Using Logic Mode "Standard" or "Standard with Automatic Closing Timer"

For Double Gate operation connect to terminal 3 ST/OP

For Single/Pedestrian Gate Operation (Double Gate Systems Only) connect to terminal 4 PD/CL

**WARNING: Accidentally reversing power polarity WILL damage the unit.**

**ENSURE TO ENABLE POWER SAVING MODE  
PAGE 1**

Using Logic Mode "Standard" or "Standard with Automatic Closing Timer"

For Full Gate operation connect to terminal 3 ST/OP

For Pedestrian Gate Operation connect to terminal 4 PD/CL

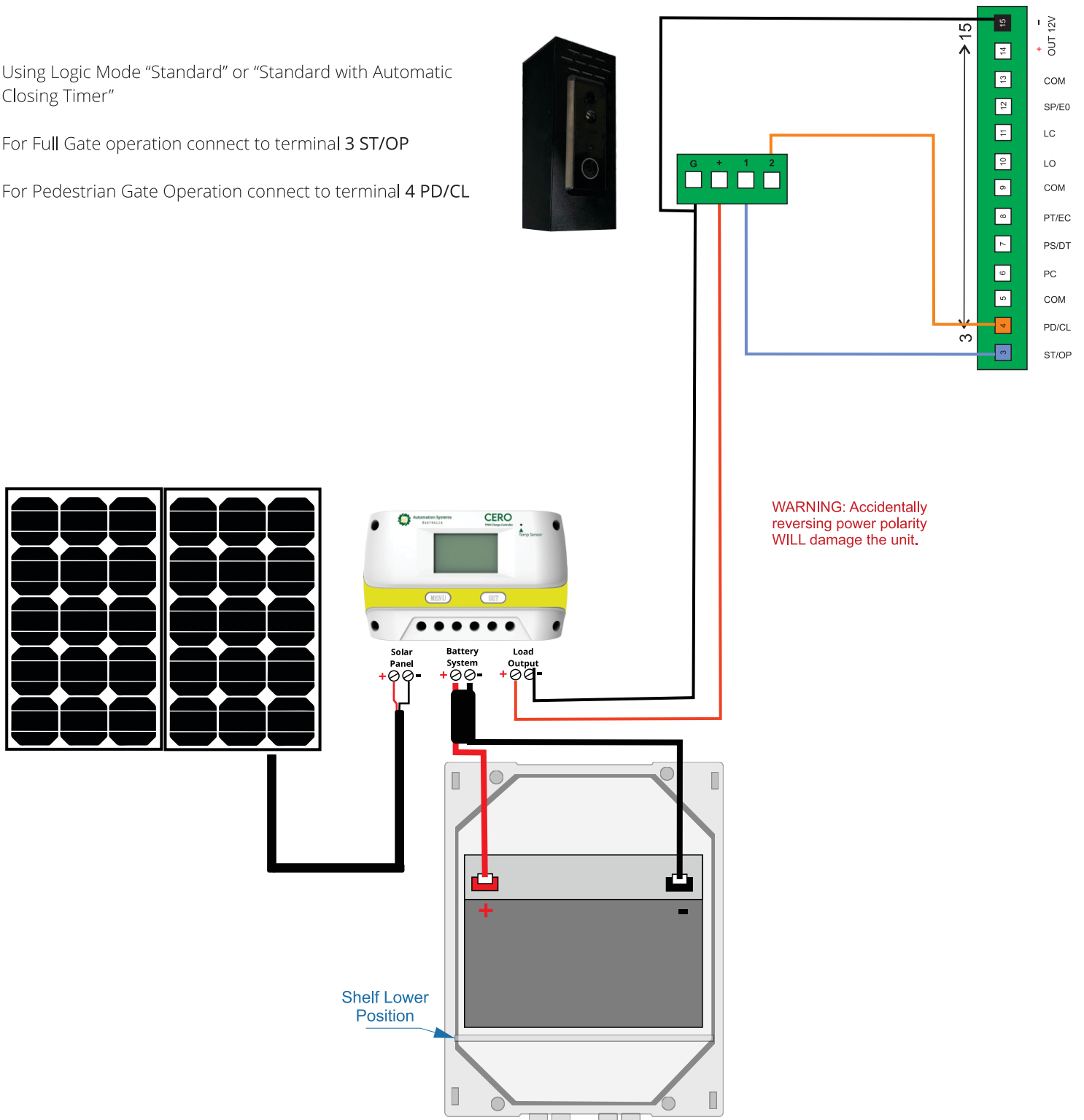

ENSURE TO ENABLE POWER SAVING MODE  
PAGE 1